

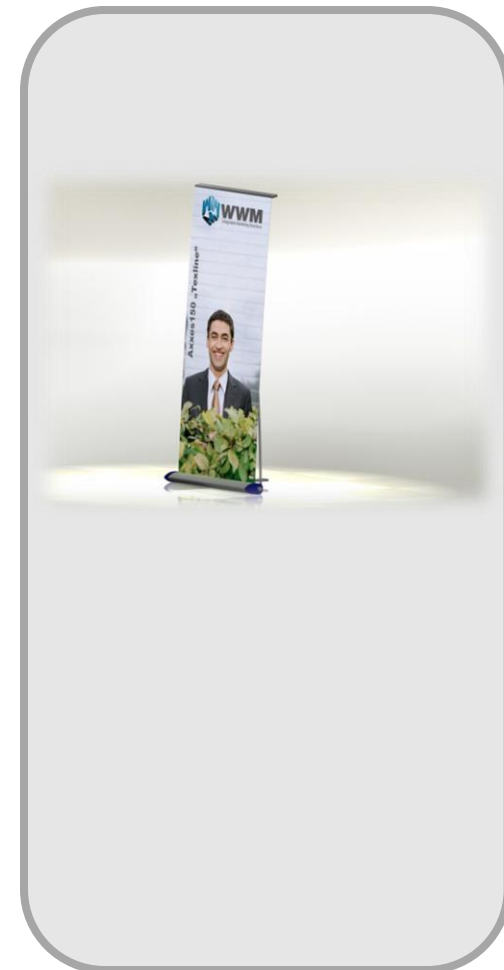

Axxes 150

Aufbauanleitung Axxes 15x

Setup-Instruction Axxes 15x



1. Entnehmen sie das Axxes 15x-System der blauen WWM und platzieren sie es auf dem Boden wie in Bild 1 zu sehen.

1. Unpack the Axxes 15x-system out of the blue WWM bag and place it on floor as shown in picture 1.



Axxes 150

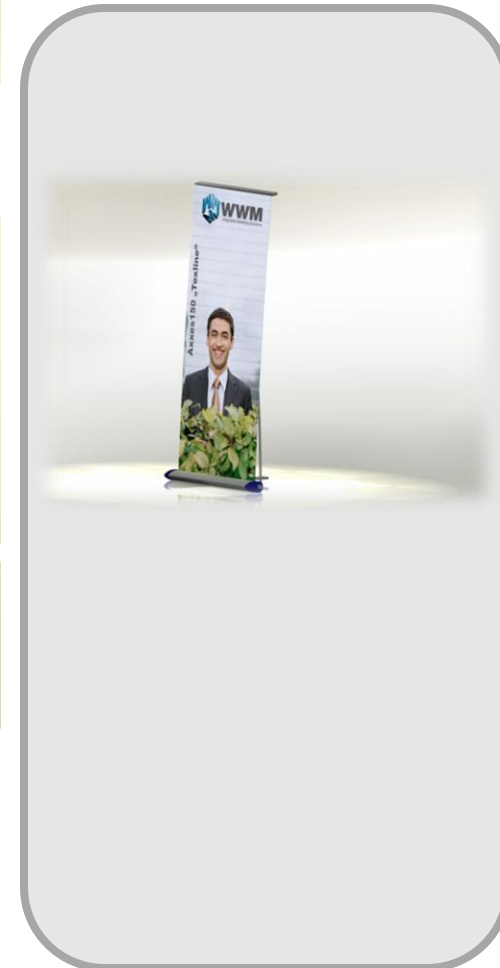
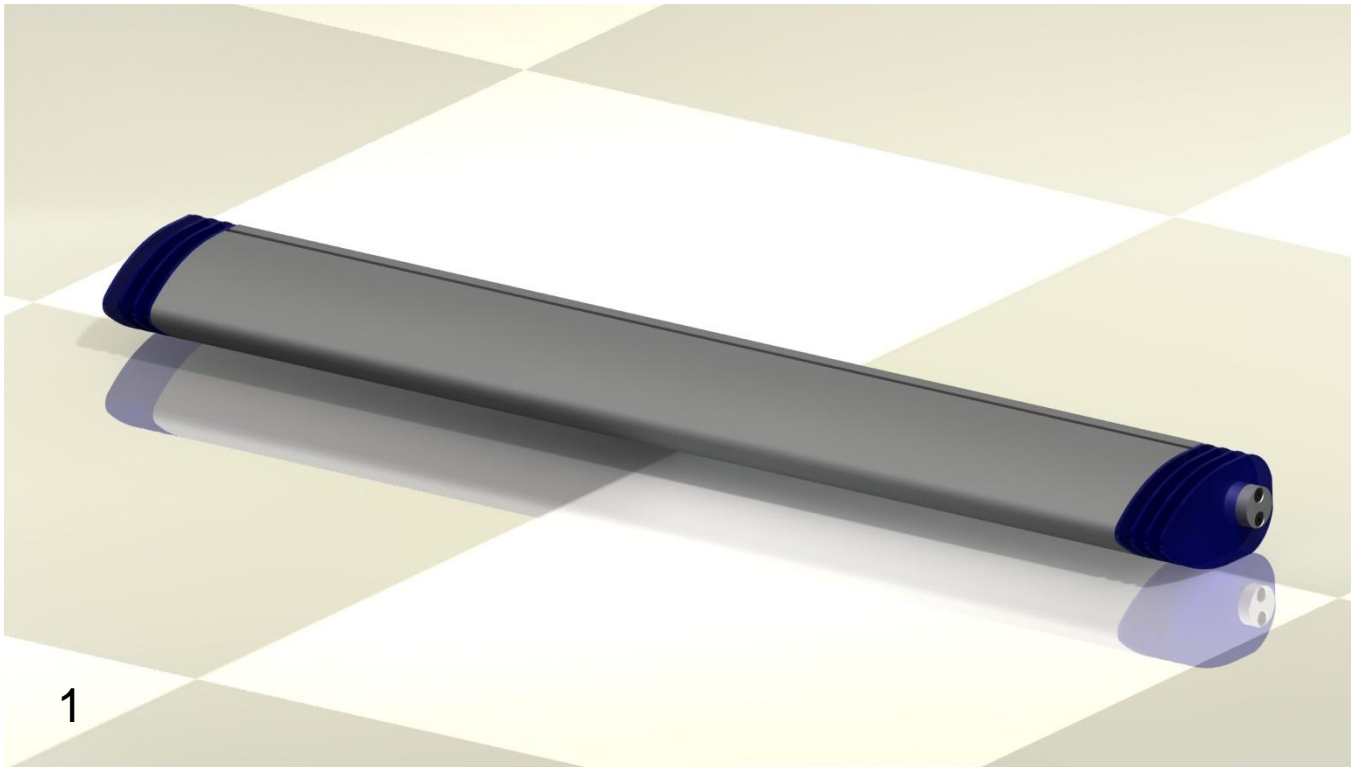

2. Lösen Sie mit dem beiliegendem Werkzeug die im Bereich des roten Kreises zu findende Schraube (grüner Kreis). Drehen Sie diese nicht vollständig heraus, sondern nur so weit, dass Sie die Lamellen Endkappe (blau) problemlos herausziehen können. Entnehmen Sie der Hohlkammer des Systems sämtliche Komponenten.

2. Unfasten screw seen in red circle with enclosed tool. Do not unfasten screw not full, but to the point where you can easily extract Lamella Endcap (blue). Extract any components out of systems hollow section.



Axxes 150

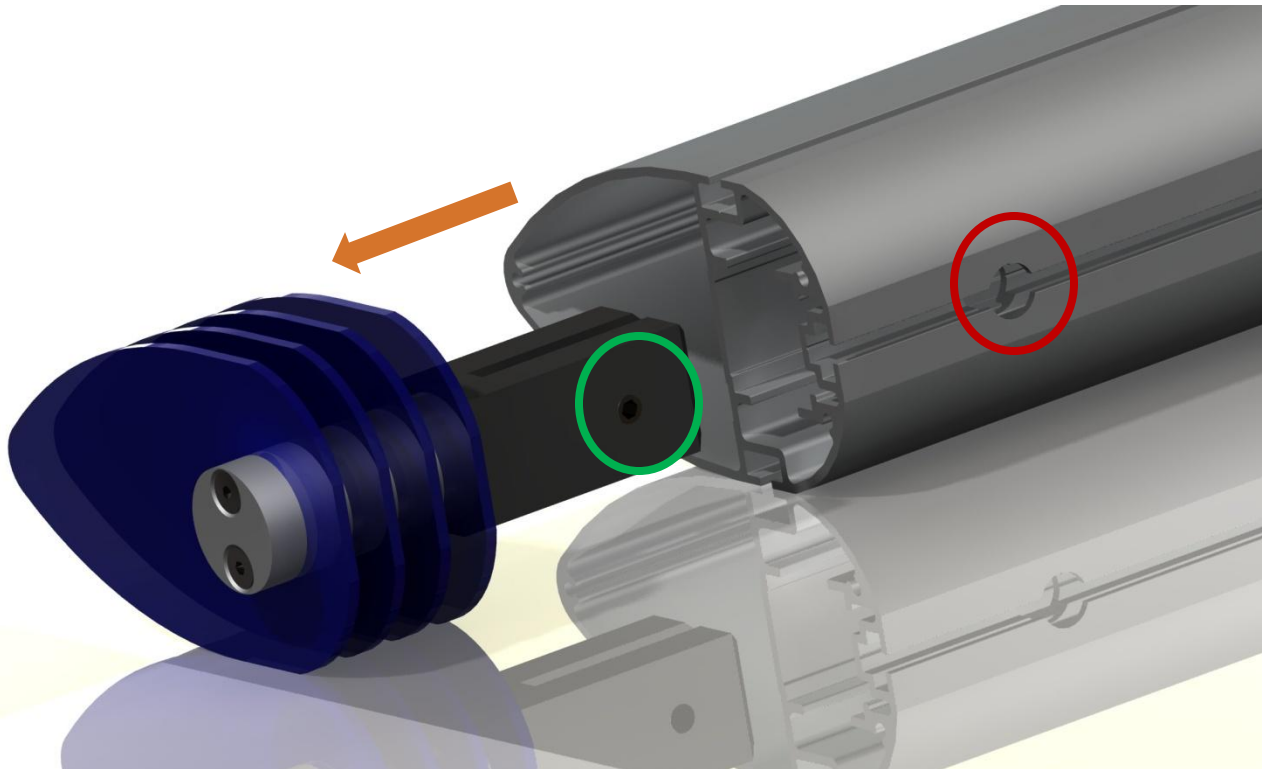

3. Befestigen Sie nun durch Drehung des Schlosses (roter Kreis) die beiliegende, kurze Horizontal Bar mittig an der Rückseite des Systems. Zur Orientierung finden Sie einen grünen Punkt, welcher die Mitte darstellt. Nutzen Sie zur Befestigung ebenfalls das beiliegende Werkzeug.

3. Mount Horizontal Bar by turning the lock (red circle) at the backside of the system. For better orientation you'll find a green marker which shows you the middle position. As well use the enclosed tools.



Axxes 150

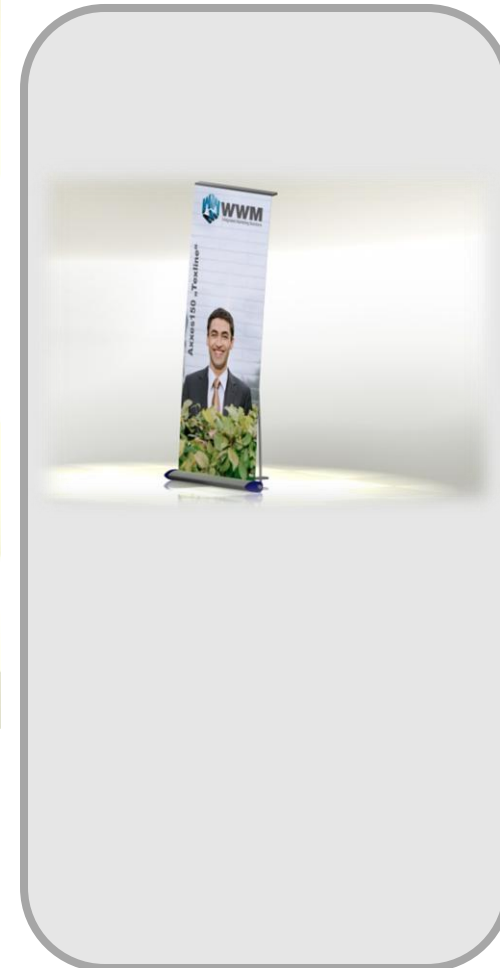
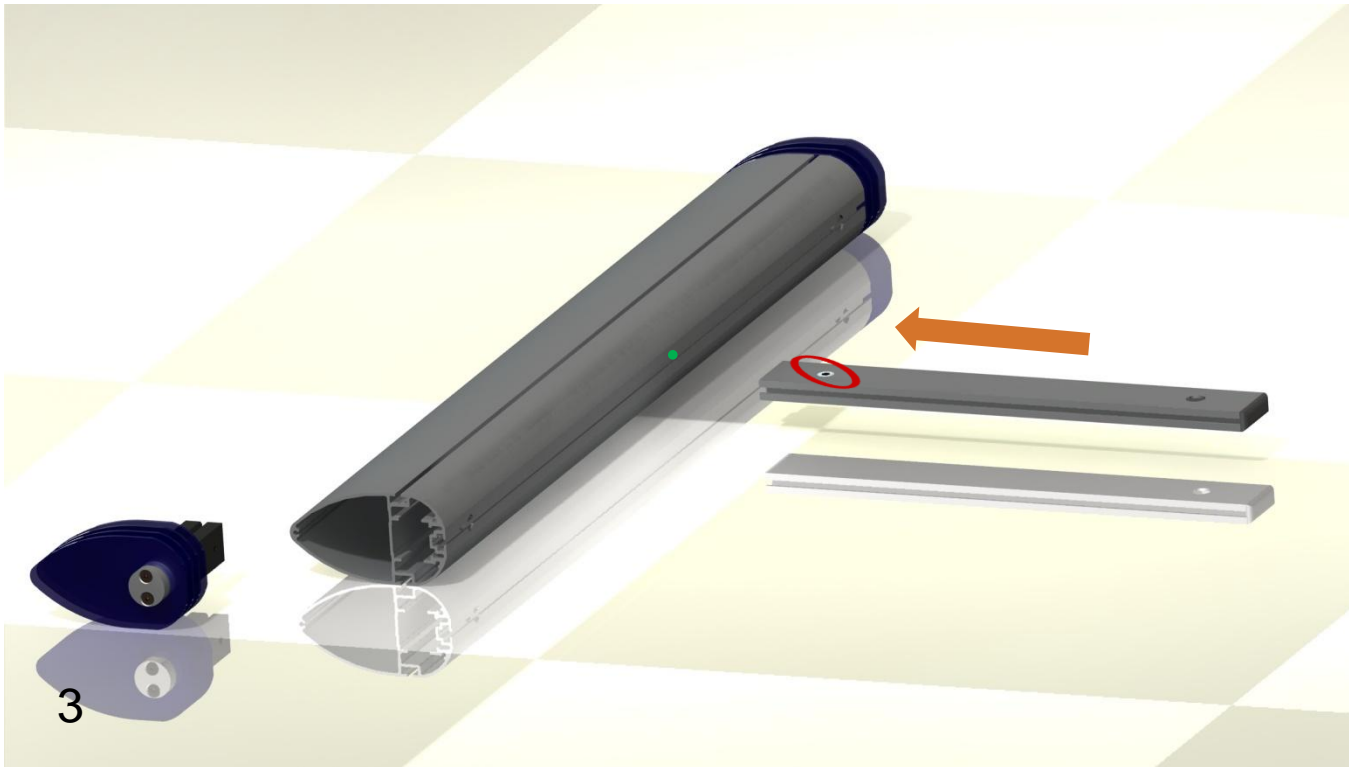

4. Stecken Sie die 3-teilige, entfaltete Grafikhaltestange in die verbliebene Bohrung der Horizontal Bar bis zum Boden.

4. Put 3-piece folded graphicpole into the remaining hole of Horizontal Bar until it touches ground.



Axxes 150

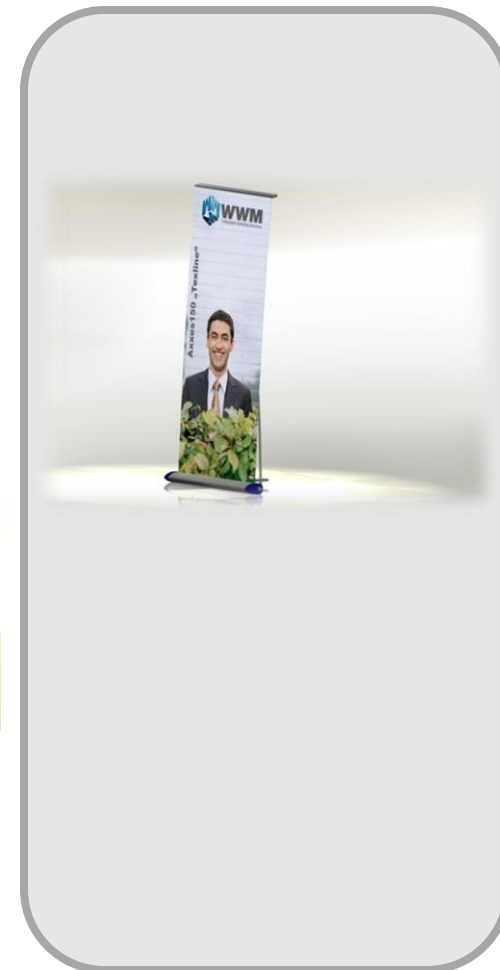
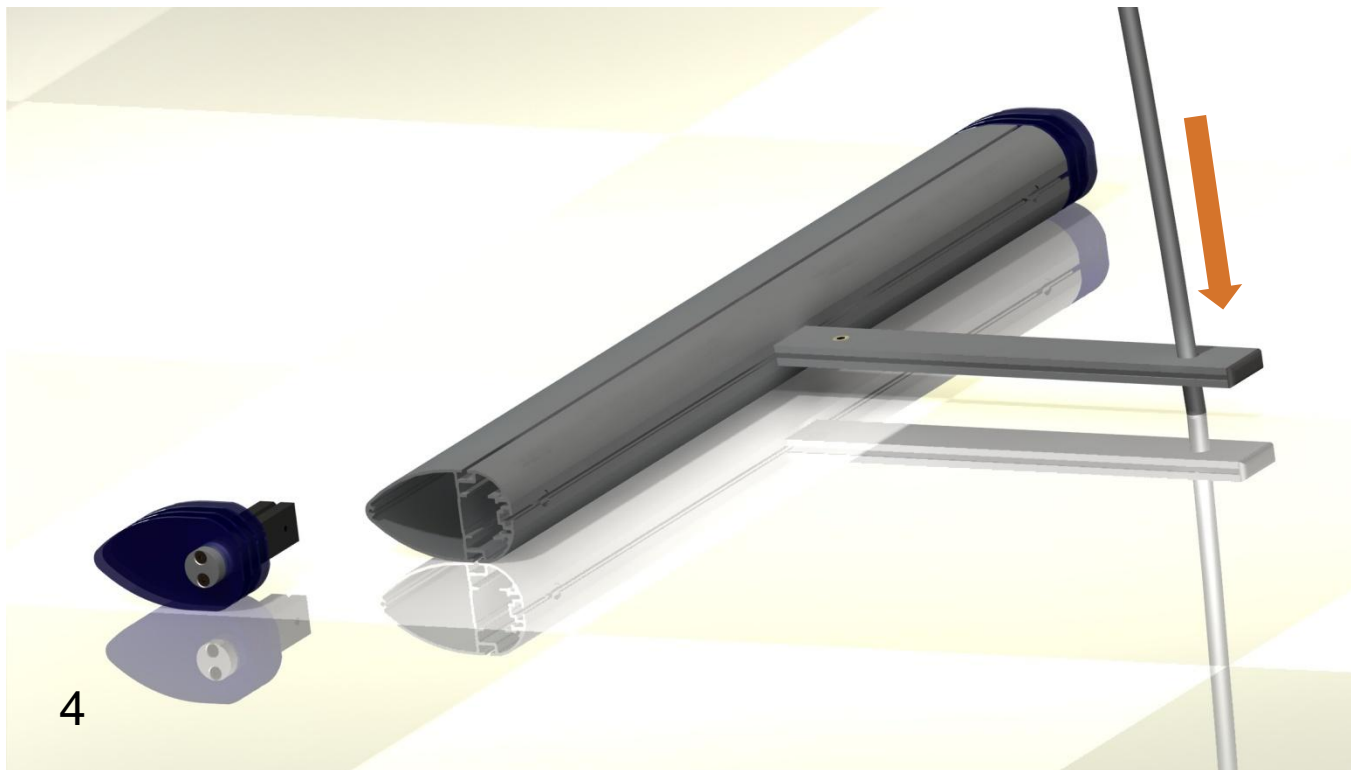

5. Schieben Sie die Grafik mit dem unteren Keder in die nach oben gerichtete Öffnung des Systems. Sie haben ebenfalls die Möglichkeit den Keder von oben in die Öffnung einzudrücken. Montieren Sie im Anschluss die Lamellen Endkappe am System und befestigen Sie diese mit der zuvor gelösten Schraube.

5. Push graphic with bottom keder into systems top orientated opening. As well you got the choice to push keder from above to the opening. Mount the lamella endcap to the system and tighten a screw.



Axxes 150

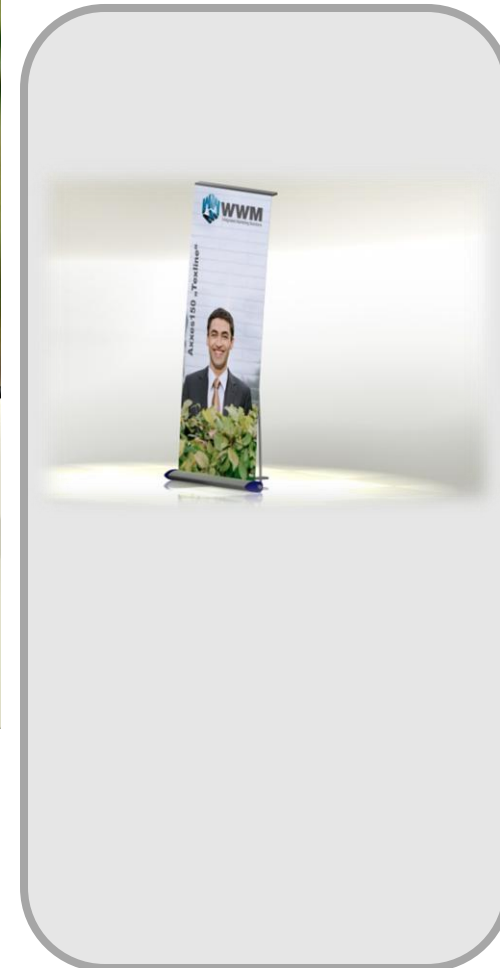
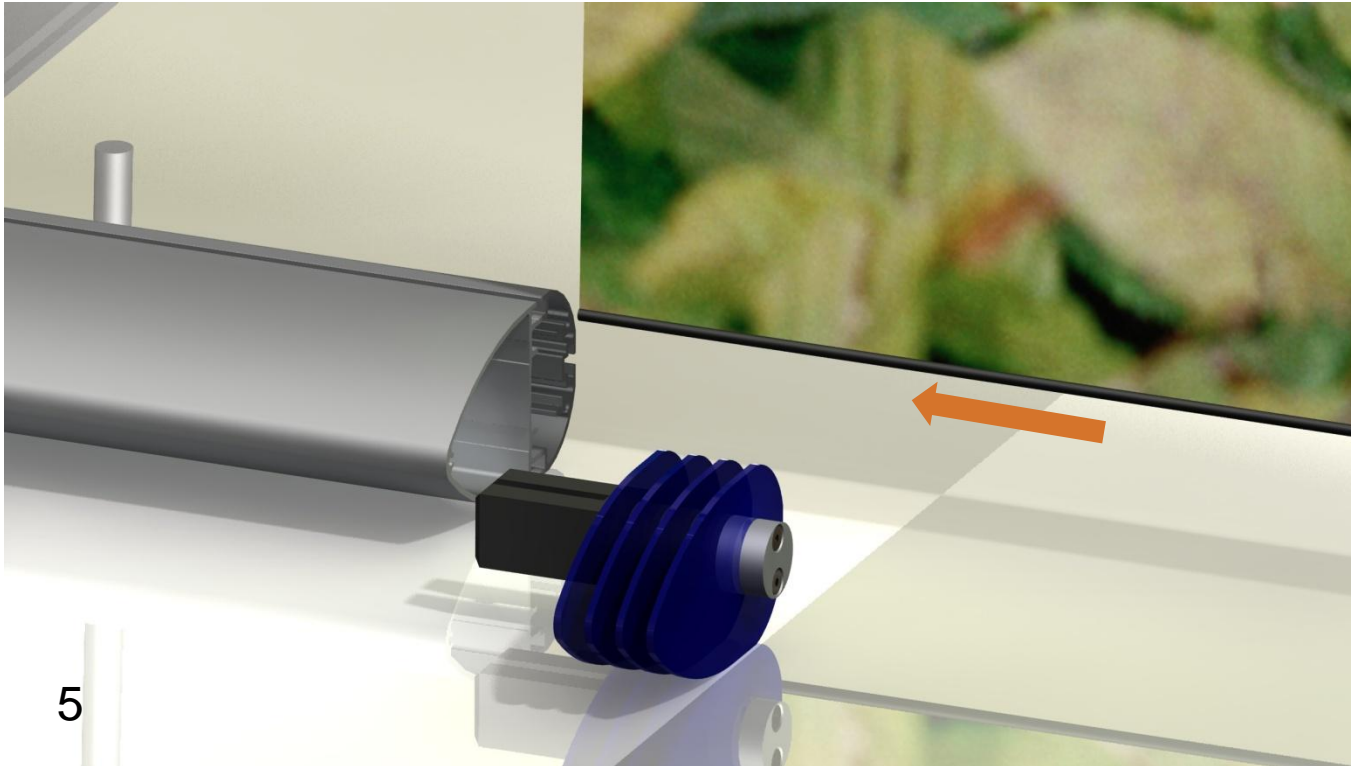

6. Strecken Sie die Grafik und verbiegen Sie die 3-teilige Grafikhaltestange um diese in die Bohrung der Grafik-Horizontal Bar einzuführen.

6. Stretch graphic and curve 3-piece folded graphicpole to mount it into the hole of graphic. Horizontal Bar.



Axxes 150

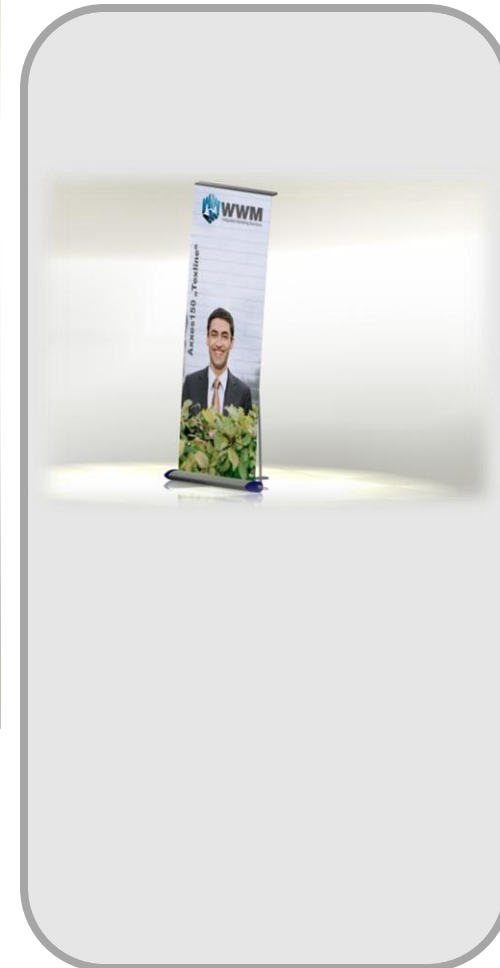
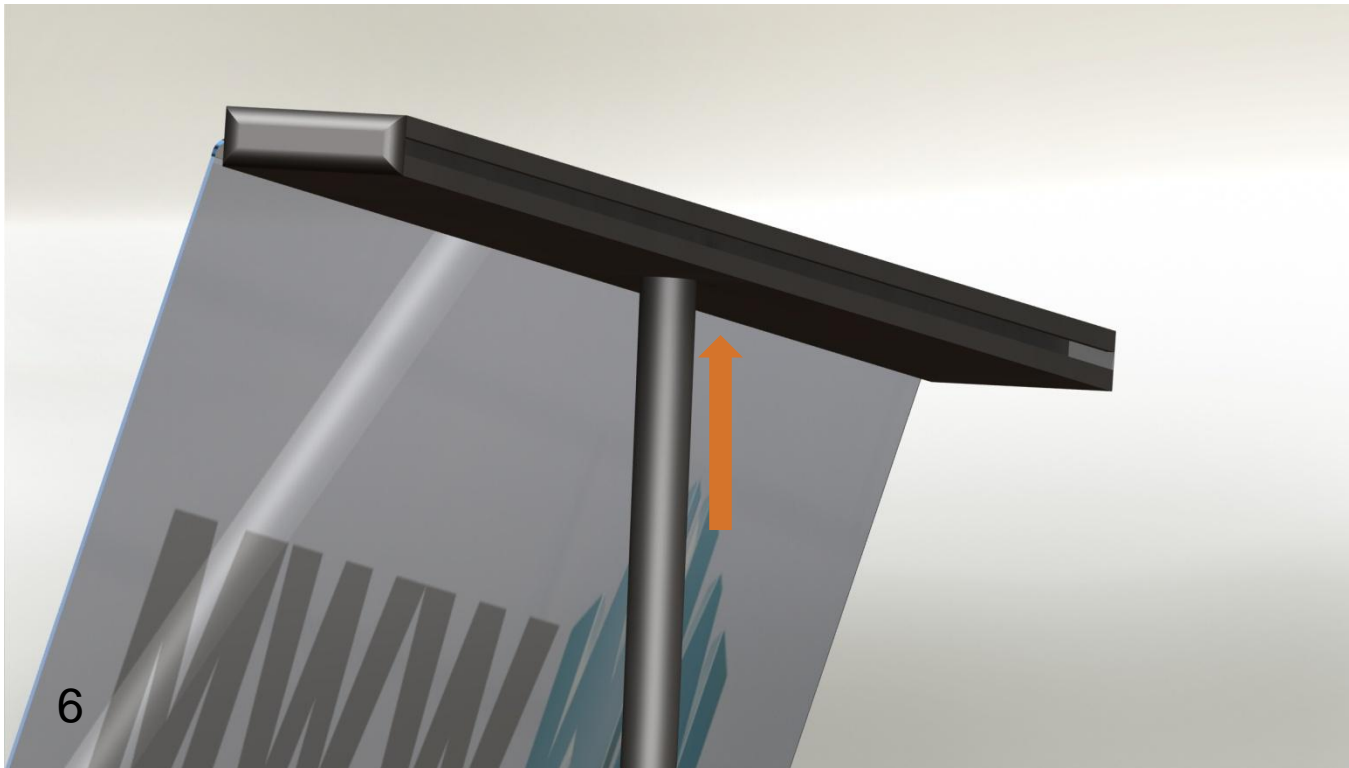

7. Das System ist nun einsatzbereit.

7. The system is now ready to use



Axxes 150

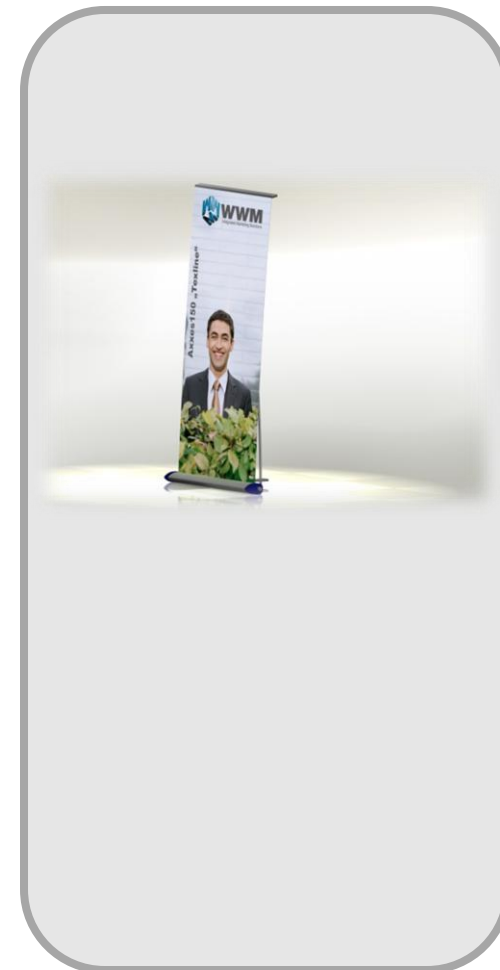
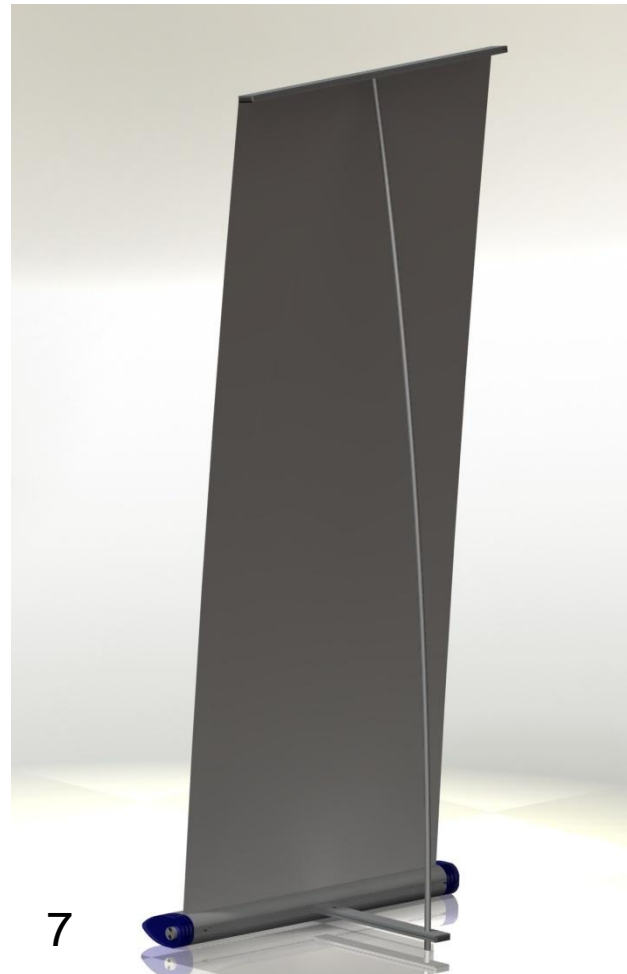

References



Axxes 150

